



US00D665558S

(12) **United States Design Patent**
Schindler

(10) **Patent No.:** **US D665,558 S**

(45) **Date of Patent:** **** *Aug. 21, 2012**

(54) **GARMENT**

(75) Inventor: **Heather Thomson Schindler**, New York, NY (US)

(73) Assignee: **Times Three Clothier, LLC**, New York, NY (US)

(*) Notice: This patent is subject to a terminal disclaimer.

(**) Term: **14 Years**

(21) Appl. No.: **29/350,288**

(22) Filed: **Nov. 13, 2009**

Related U.S. Application Data

(60) Division of application No. 29/302,500, filed on Jan. 17, 2008, now Pat. No. Des. 606,285, and a division of application No. 29/350,198, filed on Nov. 12, 2009, which is a continuation of application No. 29/302,500.

(51) **LOC (9) Cl.** **02-01**

(52) **U.S. Cl.** **D2/701**

(58) **Field of Classification Search** D2/700-703, D2/706, 708, 731, 732, 828, 840, 718, 737, D2/847, 714, 800, 717, 723, 756, 793, 841; 450/96, 94, 115, 116, 122-124, 127, 132, 450/154, 10, 15, 30, 112, 1, 3, 7, 11, 20, 450/31, 34, 63, 64, 86, 95; 2/112, 113, 69, 2/67, 70, 73, 78.1, 78.2, 78.3, 104, 105, 109, 2/110; 66/176

See application file for complete search history.

(56) **References Cited**

U.S. PATENT DOCUMENTS

26,473 A * 12/1859 Brown 450/95
(Continued)

FOREIGN PATENT DOCUMENTS

DE 8513103.2 5/1985
(Continued)

OTHER PUBLICATIONS

Left-hand image on Contents page, "Self" magazine, Jan. 2006 issue. (2 pages).*

(Continued)

Primary Examiner — Karen E. Eldridge Powers

(74) *Attorney, Agent, or Firm* — Stroock & Stroock & Lavan LLP

(57) **CLAIM**

The ornamental design for a garment, as shown and described herein.

DESCRIPTION

This application is related to co-pending U.S. Design Application 29/350,290, filed on Nov. 13, 2009, the contents of which are hereby incorporated by reference.

FIG. 1 is a front elevation view of Embodiment 1, of a garment;

FIG. 2 is a rear elevation view thereof;

FIG. 3 is a right elevation view thereof;

FIG. 4 is a left elevation view thereof;

FIG. 5 is a right side elevation view of Embodiment 2, of a garment, where the front and rear elevation views are the same as FIGS. 1-2; and,

FIG. 6 is a left elevation view of Embodiment 2, of a garment.

The sleeves are not shown in FIGS. 3-6 for ease of illustration. The center section and lower section of the claimed design is shaded to illustrate a different appearance. The dashed broken lines shown in the drawings illustrate environmental features that form no part of the claimed design. The dash-dot-dot-dash broken lines shown at the junction of the bodice with the sleeve and the interior of the bodice represent the bounds of the design and form no part of the claimed design.

The broken lines shown in the drawings are for environmental structure only and form no part of the claimed design.

1 Claim, 6 Drawing Sheets

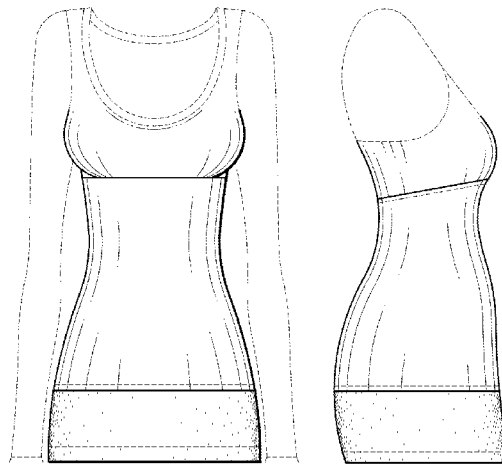

U.S. PATENT DOCUMENTS

240,569	A *	4/1881	Appleton	66/176	D234,649	S *	4/1975	Casclo	D2/703
357,068	A *	2/1887	Dably	66/176	D239,475	S *	4/1976	Casclo	D2/702
432,442	A *	7/1890	Sanford	2/113	3,949,426	A	4/1976	George	
445,945	A *	2/1891	Bohne	66/176	4,377,007	A	3/1983	Sudjian	
570,696	A *	11/1896	Brown	66/176	4,916,755	A *	4/1990	Feigenbaum et al.	2/67
672,028	A *	4/1901	Appleton	66/176	4,976,653	A	12/1990	White	
839,699	A *	12/1906	Anderson	2/67	5,083,316	A	1/1992	Kuehner	
933,739	A *	9/1909	Bodensiek	450/7	5,094,648	A	3/1992	Turner	
1,007,047	A *	10/1911	Albers et al.	2/109	5,461,725	A	10/1995	Witzczak	
1,088,371	A *	2/1914	Rossiter	450/94	5,566,392	A	10/1996	Dzelzkalns	
1,110,749	A	9/1914	De Blieux		5,605,060	A	2/1997	Osborne	
1,121,005	A	12/1914	Farnsworth		D391,740	S	3/1998	Barrington et al.	
1,191,865	A	7/1916	Workman		5,915,531	A *	6/1999	Hilpert et al.	2/69
1,249,446	A	12/1917	Mell		6,000,993	A *	12/1999	Erwin	450/7
1,323,748	A *	12/1919	Gitenstein	2/78.3	6,061,832	A	5/2000	Morrison	
1,342,188	A *	6/1920	Jacob	2/78.1	6,185,741	B1	2/2001	Kehoe	
1,587,099	A *	6/1926	Williams	2/78.2	6,282,720	B1 *	9/2001	Mayer	2/113
1,683,510	A *	9/1928	Carl	450/20	D452,600	S *	1/2002	Kim	D2/702
1,770,615	A *	7/1930	Herlich	2/67	D453,058	S *	1/2002	Kim	D2/703
1,774,613	A *	9/1930	Pidgeon	450/20	D453,255	S *	2/2002	Kim	D2/702
1,777,215	A	9/1930	McGill		6,430,748	B1 *	8/2002	Burkhart	2/78.1
1,813,043	A	7/1931	Foreman		D476,464	S	7/2003	Jenkins	
1,828,310	A *	10/1931	Bergh	2/67	6,846,217	B1	1/2005	Struble et al.	
1,886,049	A	11/1932	Rothblum		D556,978	S *	12/2007	Thunstedt	D2/847
1,894,062	A *	1/1933	Schrank	2/73	7,395,557	B1	7/2008	Ledyard	
1,897,619	A *	2/1933	Powell	2/67	D595,480	S *	7/2009	Giugliano	D2/702
1,899,022	A *	2/1933	Duisdieker	2/67	7,905,117	B2 *	3/2011	Kronback	66/176
D91,329	S	5/1933	Redman		2006/0242748	A1	11/2006	Martz	
1,931,822	A *	10/1933	Hoffman	450/95	2007/0094765	A1 *	5/2007	Summers et al.	2/113
1,953,797	A *	4/1934	Daniel	2/67	2008/0134409	A1 *	6/2008	Karasina	2/117
1,977,329	A *	10/1934	Tobin	2/113	2008/0229474	A1 *	9/2008	Fons et al.	2/113
RE19,380	E *	11/1934	Craig	2/78.2	2008/0244805	A1 *	10/2008	Griffin	2/114
2,000,073	A *	5/1935	Goas	66/176					
2,033,456	A	3/1936	Cunningham						
2,035,377	A *	3/1936	Redmond	2/111					
2,040,058	A *	5/1936	Craig	66/176					
2,040,561	A *	5/1936	Ernst	450/34					
2,052,784	A *	9/1936	Charles	66/176					
2,052,935	A *	9/1936	Moran	450/10					
2,076,748	A	4/1937	Schweig						
2,097,777	A	11/1937	Rothman						
2,098,881	A *	11/1937	Robbins	450/27					
2,098,882	A *	11/1937	Robbins	450/27					
D110,662	S *	7/1938	Rielly	D2/714					
2,190,030	A	2/1940	Kops						
D128,536	S *	7/1941	Weil	D2/702					
D129,078	S *	8/1941	Monteil	D2/800					
D129,894	S *	10/1941	Abeles	D2/703					
2,274,382	A	2/1942	Richman						
2,310,103	A *	2/1943	McDonald	2/113					
2,335,751	A	11/1943	Friedman						
2,579,547	A *	12/1951	Cadous	450/112					
D170,694	S *	10/1953	Kahn	D2/702					
D174,038	S *	2/1955	Goldstein	D2/702					
D174,114	S *	3/1955	Dior	D2/702					
D174,115	S *	3/1955	Dior	D2/703					
D174,194	S *	3/1955	Prochaska	D2/702					
D174,329	S *	3/1955	Katz	D2/700					
2,723,396	A *	11/1955	Stack	450/58					
D177,982	S *	6/1956	Kahn	D2/702					
D181,626	S *	12/1957	Cassini	D2/800					
2,963,022	A *	12/1960	Spetelnik	450/15					
D191,347	S	9/1961	Herman						
3,026,875	A *	3/1962	Kaupp	450/116					
3,036,574	A *	5/1962	Jeffrey	450/30					
3,060,446	A	10/1962	Horne						
3,066,675	A	12/1962	Herman						
3,217,713	A	4/1964	Kunel						
D211,231	S *	6/1968	Sallasky	D2/702					
3,421,513	A	1/1969	Landau						
3,422,818	A	1/1969	Erteszek						
3,454,013	A *	7/1969	Cahill	450/116					
3,479,844	A	11/1969	Silvain						
3,556,106	A	1/1971	Rosner						
3,582,993	A	6/1971	Keller						
3,683,910	A *	8/1972	McKenna	602/68					
D224,700	S *	9/1972	Bienefeld	D2/700					
3,699,590	A	10/1972	Webber et al.						

FOREIGN PATENT DOCUMENTS

DE	202005000716	U1	4/2005
EP	0174179		3/1986
EP	0774241		5/1997
EP	1082951		3/2001
EP	1125566		8/2001
EP	000385562-0106		7/2005
EP	000454202-0027		12/2005
EP	000454202-0121		12/2005
EP	000633755-0027		12/2006
EP	000730403-0023		5/2007
GB	116526		6/1918
GB	212307		3/1924
GB	1603600		11/1981
GB	3020687		7/2005
GB	4004524		10/2007
JP	2-82707		6/1990
JP	2001-172806		6/2001
JP	2002-138302		5/2002
JP	2003-129303	A	5/2003
JP	2005-281893	A	10/2005
JP	2006-316359	*	11/2006
JP	2006-316359	A	11/2006
JP	2007-146337	*	6/2007
JP	2007-146337	A	6/2007
JP	2007-303002	*	11/2007
JP	2008-156812	A	7/2008
WO	96/08217		3/1996
WO	01/75201		10/2001

OTHER PUBLICATIONS

Cover and ad page picturing Serena Williams, "Lucky" magazine, Oct. 2003. (2 pages).*

Mila Kunis Magazine Cover, [on-line]; [downloaded from the Internet on May 5, 2012]; [cover identified is for Oct. 2003 issue]; URL: <http://www.whosdatedwho.com/tpx_1783/mila-kunis/magazinecovers_13>. (4 pages).*

Yummie Tummie and Maidenform Settle Patent Infringement and Invalidity Lawsuits, Fox News 44, PR Newswire (2011). <http://www.fox44now.com/story/15242333/yummie-tummie-and-maidenform-settle-patent-infringement-and-invalidity-lawsuits?clienttype=printable>—printed Aug. 12, 2011.

Maidenform Brands, Inc. Reports Second Quarter 2011 Results and Provides Guidance for Full Year 2011, News Releases—General News, Iselin, NJ—PRNewswire via COMTEX/ Aug. 10, 2011.

- Associated Press, "Maidenform 2Q net income drops on settlement," *Forbes.com* (Aug. 10, 2011). http://www.forbes.com/feeds/ap/2011/08/10/business-specialized-consumer-services-us-earns-maidenform_8611962.html?partner=email—printed Aug. 12, 2011.
- Maidenform's Responses and Objections to TTC's First Set of Request for Production of Documents (Nos. 1-144)—Aug. 24, 2010.
- Maidenform's Second Set of Requests for the Production of Documents and Things (Nos. 78-123)—Sep. 3, 2010.
- Maidenform's Second Set of Interrogatories (Nos. 16-17)—Sep. 3, 2010.
- Maidenform's First Supplemental Responses and Objections to TTC's First Set of Interrogatories—Sep. 10, 2010.
- TTC's Responses to Maidenform's Second Set of Requests for Production (Nos. 78-123)—Oct. 12, 2010.
- TTC's Written Responses to Maidenform's Second Set of Interrogatories (Nos. 16-17). *San Francisco Chronicle* article—MF0001240-1242. *Women's Wear Daily* article—MF0001087-1088. Oct. 12, 2010.
- Maidenform's Responses and Objections to TTC's Supplemental First Set of Interrogatories (Nos. 1A-18A)—Nov. 2010.
- Donner's Objections to Maidenform's Request for Production of Documents Included in the Subpoena to I. Donner—Feb. 22, 2011.
- 1A—Nike Fly Lightweight + Women's Sports Top, Nike, <http://clothing-and-accessories.become.com/nike-fly-lightweight-womens-sports-top-com> . . . (URL is incomplete) received by Applicant Aug. 24, 2010.
- 2A—Pretty Shapewear Camisole, SassyBax, www.sassybax.com/pretty-camisole.php received by Applicant Aug. 24, 2010.
- 3A—Underwire Torso Trim, SassyBax, www.sassybax.com/underwire-trim.php received by Applicant Aug. 24, 2010.
- 4A—The Torso Trim, SassyBax, www.sassybax.com/torso_trim.php received by Applicant Aug. 24, 2010.
- 5A—Belly Bra, JCPenney, www.jcpenney.com/jcp/X6.aspx?DeptID=51669&CatID=51669&Grptyp=Size&Item . . . (URL is incomplete) received by Applicant Aug. 24, 2010.
- 6A—Secret Sculptor Tunic, Shape Fx, www.shapefx.com/store/Shapewear_Shop_by_Category_Camis_Tanks_Se . . . (URL is incomplete) received by Applicant Aug. 24, 2010.
- 7A—The Skinny, www.skinnycami.biz/files/ received by Applicant Aug. 24, 2010.
- 8A—Simplicity Lingerie Strap Camisole, Spanx, www.spanx.com/product/index.jsp?productId=3977353&cp=2992553.4015964&par . . . (URL is incomplete) received by Applicant Aug. 24, 2010.
- 9A—Hide & Sleek Cami, Spanx, <http://web.archive.org/> . . . (URL is incomplete) received by Applicant Aug. 24, 2010.
- 10A—Hide & Sleek Full Slip 18 Inch 060A, Spanx, www.herroom.com/Spanx-060A-Hide-Sleek-Full-Slip-18-Inch.shtml received by Applicant Aug. 24, 2010.
- 11A—Teez-Her The Skinny Tank, Teez-Her, www.essentialapparel.com/index.cfm/a/catalog.prodshow/vid/72638/catid/267/Teez . . . (URL is incomplete) received by Applicant Aug. 24, 2010.
- 12A—Cami-Rolls, <http://camirolls.com/shop.shtml> received by Applicant Aug. 24, 2010.
- 13A—TummyTee, www.redefyne.com/tummytee.html received by Applicant Aug. 24, 2010.
- 14A—Champion Seamless Empire Top with Built-In Sports Bra, Champion, www.championusa.com/Champion/Products/Women-Champion/Women_ShopByCa . . . (URL is incomplete) received by Applicant Aug. 24, 2010.
- 15A—Cosabella Smooth Bodyshaper Cami SHPE702, CosaBella, www.herroom.com/Cosabella-Shpe702-Smooth-Bodyshaper-Cami.shtml received by Applicant Aug. 24, 2010.
- 16A—Daisy Fuentes Slimming Camisole, Kohls, www.kohls.com/upgrade/webstore/product_page.jsp?Product%3C%3Eprd_id=8 received by Applicant Aug. 24, 2010.
- 17A—582L Countouring Balconet Bra Cami-Long Torso, Dumi Shapewear, www.du-mi.com/store/product-info.php?pid12.html received by Applicant Aug. 24, 2010.
- 18A—Very Precious, Great Glam, <http://greatglam.com/pd-very-precious.cfm> received by Applicant Aug. 24, 2010.
- 19A—Sensual Charm, Great Glam, <http://greatglam.com/pd-sensual-charm1.cfm> received by Applicant Aug. 24, 2010.
- 20A—Yalof Schwartz, Suze, "Too Busy for the Gym?" *Glamour*, www.glamour.com/fashion/blogs/slaves-to-fashion/2007/10/too-busy . . . (URL is incomplete) received by Applicant Aug. 24, 2010. Page shown present on Internet approximately Oct. 2007.
- 21A—Underwire Torso Trim, Sassybax, <http://web.archive.org/web/20071020033219/sassybax.com> received by Applicant Aug. 24, 2010. Page shown present on Internet on Oct. 20, 2007.
- 22A—Nancy Ganz The Belly Band Convertible Bodybriefer 3313, Nancy Ganz, www.herroom.com/NancyGanz . . . (URL is incomplete) received by Applicant Aug. 24, 2010. Page shown present on Internet on Nov. 25, 2007.
- 23A—Spanx Hide & Sleek Full Slip 060A, Spanx, www.herroom.com/Spanx-Hide . . . (URL is incomplete) received by Applicant Aug. 24, 2010. Page shown on Internet on Nov. 1, 2007.
- 24A—Spanx Hide & Sleek Cami 050, Spanx, www.herroom.com/Spanx . . . (URL is incomplete) received by Applicant Aug. 24, 2010. Page shown present on Internet on Oct. 30, 2007.
- 25Aa, 25Ab, 25Ac—Collection of Photographs received by Applicant on Dec. 8, 2010 received by Applicant Aug. 24, 2010.
- 26A—Alleged Ann Mason Receipt; Nov. 26, 2006.
- 27Aa, 27Ab—Declaration of Ann Mason; May 19, 2007.
- 28A—Yummie Tummie and Maidenform Settle Patent Infringement and Invalidity Lawsuits, *Fox News 44*, PR Newswire (2011). <http://www.fox44now.com/story/15242333/yummie-tummie-and-maidenform-settle-patent-infringement-and-invalidity-lawsuits?clienttype=printable>—printed Aug. 12, 2011.
- 29A—Maidenform Brands, Inc. Reports Second Quarter 2011 Results and Provides Guidance for Full Year 2011, News Releases—General News, Iselin, NJ—PRNewswire via COMTEX/ Aug. 10, 2011.
- 30A—Associated Press, "Maidenform 2Q net income drops on settlement," *Yahoo News* (Aug. 10, 2011). <http://news.yahoo.com/maidenform-2q-net-income-drops-settlement-125621767.html>—printed Apr. 20, 2012.
- 1—Email from Christine Conforte to Heather Schindler "FW: Tummy Tee," sent Dec. 1, 2006.
- 2—Email from Christine Conforte to Heather Schindler "Liz Lange," sent Dec. 13, 2006.
- 3—Email from Heather Schindler to Christine Conforte "Liz Lange," sent Dec. 13, 2006.
- 4—Email from Christine Conforte "Liz Lange," sent Dec. 11, 2006.
- 5—Email from Heather Schindler to Christine Conforte "Liz Lange," sent Dec. 9, 2006.
- 6—Email from Christine Conforte to Heather Schindler "Liz Lange," sent Dec. 7, 2006.
- 7—Email from Heather Schindler to Christine Conforte "Liz Lange," sent Dec. 7, 2006.
- 8—Email from Christine Conforte to Heather Schindler, "Liz Lange," sent Dec. 6, 2006.
- 9—Email from Heather Schindler to Liz Lange copying Michelle Mooring and Christine Conforte, "Follow Up," sent Jan. 24, 2007.
- 10—Email from Liz Lange to Heather Schindler copying Christine Conforte and Michelle Mooring, "Follow Up," sent Jan. 23, 2007.
- 11—Email from Heather Schindler to Liz Lange copying Christine Conforte and Michelle Mooring, "Follow Up," sent Jan. 23, 2007.
- 12—Email from Liz Lange to Heather Schindler copying Christine Conforte "Follow Up," sent Jan. 19, 2007.
- 13—Email from Heather Schindler to Christine Conforte copying Michelle Mooring "FW: TummyTube," sent Jan. 31, 2007.
- 14—Email from Christine Conforte to Heather Schindler copying Liz Lange "Tummy Tube," sent Jan. 30, 2011.
- 15—Email from Heather Schindler to Liz Lange copying Michelle Mooring and Christine Conforte "TummyTube," sent Feb. 6, 2007.
- 16—Email from Liz Lange to Heather Schindler and Christine Conforte "TummyTube," sent Feb. 2, 2007.
- 17—Email from Heather Schindler to Christine Conforte copying Liz Lange "TummyTube," sent Feb. 2, 2007.
- 18—Email from Christine Conforte to Heather Schindler copying Liz Lange "TummyTube," sent Jan. 30, 2007.
- 19—"Style Spy," *Lucky Magazine*, p. 26, Jan. 2002 issue.
- 20—LeCove swimwear catalog, p. 26 received by Applicant Aug. 24, 2010.

- 21—JC Penney maternity catalog, p. 165 received by Applicant Aug. 24, 2010.
- 22—WWD Intimates catalog, cover received by Applicant Aug. 24, 2010.
- 23—“Fashion Q & A,” Shape Magazine, p. 68. Jan. 2008 issue.
- 24—Vogue Magazine, vol. 15, cover received by Applicant Aug. 24, 2010.
- 25—“Self Selects,” Self Magazine, p. 162. Jun. 2000 issue.
- 26—“Do good while you shop,” Lucky Magazine, p. 286. Oct. 2006 issue.
- 27—“Photo Finish,” WWD Intimates catalog. 2006.
- 28—“Shapewear Report,” In Style Magazine, pp. 338-346. Sep. 2007 issue.
- 29—Self Magazine advertisements. Jun. 2007 issue.
- 30—Self Magazine, p. 33. Dec. 2007 issue.
- 31—“My best stress bust is . . .,” Self Magazine, p. 200. Apr. 2002 issue.
- 32—Times Three Clothier, LLC Sales Order No. 1000, Sales Order Date Apr. 30, 2007.
- 33—Email from Ivan A. Saperstein to Heather Schindler copying Michelle Mooring and J. Schindler “Gatsby’s” sent Jul. 20, 2007.
- 34—Email from Heather Schindler to Ivan A. Saperstein copying Michelle Mooring and J. Schindler “Gatsby’s” Jul. 20, 2007.
- 35—Email from Ivan A. Saperstein to Michelle Mooring, Heather Schindler and J. Schindler “Gatsby’s” Jul. 20, 2007.
- 36—Invoice billed and shipped to Seams Beautiful-Carolyn Weaver, Invoice # 00006138, Aug. 11, 2006.
- 37—Invoice billed and shipped to Seams Beautiful-Carolyn Weaver, Invoice # 00006155, Aug. 25, 2006.
- 38—Packing Slip to Seams Beautiful, Aug. 25, 2006.
- 39a, 39b, 39c, 39d, 39e, 39f, 39g, 39h, 39i—*Maidenform v. Times Three Clothier LLC d/b/a Yummie Tummie*, Case No. 10-cv-1661 (GBD)—Skinny Cami Declarations. pp. 1-118 (submitted in 9 parts) received by Applicant Dec. 14, 2010.
- 40—Applicant’s Specifications. pp.1-3 (submitted in 1 part) dated May 24, 2007-Jun. 11, 2007.
- 41—Maidenform’s Initial Disclosures—Jul. 9, 2010. pp. 1-13 (submitted in 1 part).
- 42—Maidenform’s Responses and Objections to TTC’s First Set of Interrogatories (Nos. 1-18)—Aug. 24, 2010. pp. 1-12 (submitted in 1 part).
- 43—Skinny Camisole Slimmer Corset Shaper Girdle, http://co103w.co1103.mail.live.com/mail/RteTrame_15.1.3059.0405.html?pf=pf (URL is incomplete). Pages 1-3 (submitted in 1 part) received by Applicant Aug. 24, 2010.
- 44a, 44b, 44c—Applicant’s Tummy Tees. pp. 1-3 (submitted in 3 parts). 6Ba is Applicant’s Tummy Tee early prototype sewn in Feb./Mar. 2005. 6Bb and 6Bc are photos of Applicant’s production sample first received May 30, 2007.
- 45—Gazelle Sleeveless Long Shirt, Adidas, www.shopadidas.com/product/index.jsp?productID=3847890&v2=y&cp=3748175.3 . . . (URL is incomplete) received by Applicant Aug. 24, 2010.
- 46—Super Soft Slimmer Tank, MyShape, www.myshape.com/shop/style/11906?ci_sku=11906&tutm_source . . . (URL is incomplete) received by Applicant Aug. 24, 2010.
- 47—Ann Michell Spaghetti Strap Tank Top Style 982, Lauren Silva, www.laurensilva.com/Ann_Michell_Spaghetti_Strap_Camisole_Control_Shirt_p/an . . . (URL is incomplete) received by Applicant Aug. 24, 2010.
- 48—New Marilyn Monroe Smoothing Camisole 7762, ebay, www.cgi.ebay.com/New-Marilyn-Monroe-Smoothing-Camisole-7762-28 . . . (URL is incomplete) received by Applicant Aug. 24, 2010.
- 49—Nancy Ganz The Belly Band Convertible Bodybriefer 3313, Her Room, www.herroom.com/Nancy-Ganz-3313-The-Belly-Band-Convertible-Bodyvriefer.sht . . . (URL is incomplete) received by Applicant Aug. 24, 2010.
- 50—Nike Seamless Airborne Women’s Long Tank Top, Nike, http://store.nike.com/us/en_us/?l=shop.pdp,ctr-inline/cid-1/pid-282277/pgid-238467 received by Applicant Aug. 24, 2010.

* cited by examiner

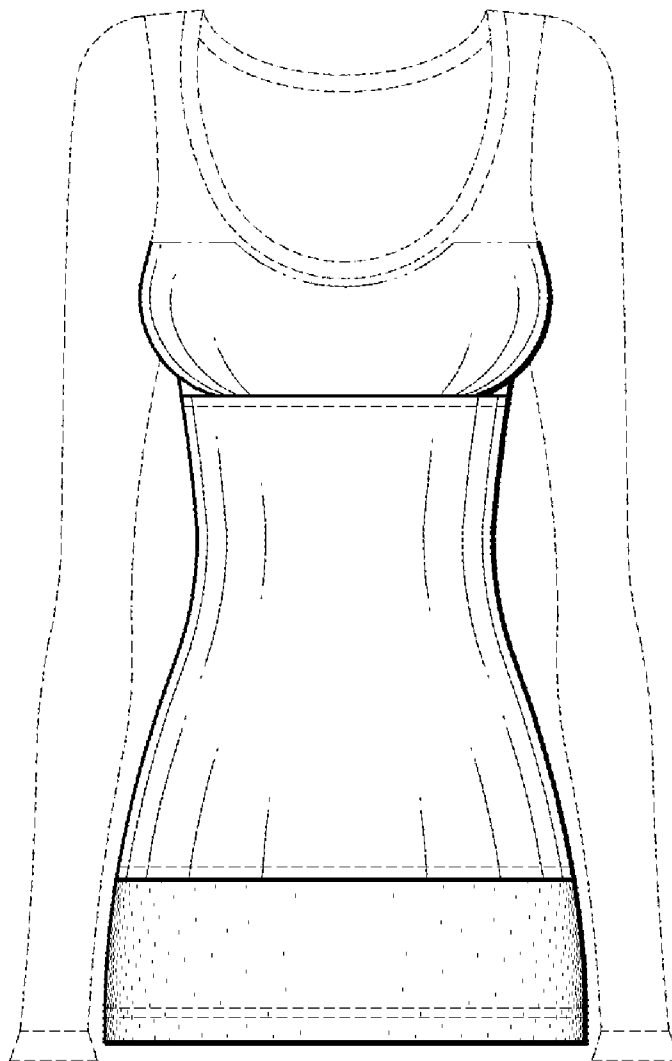

FIG. 1

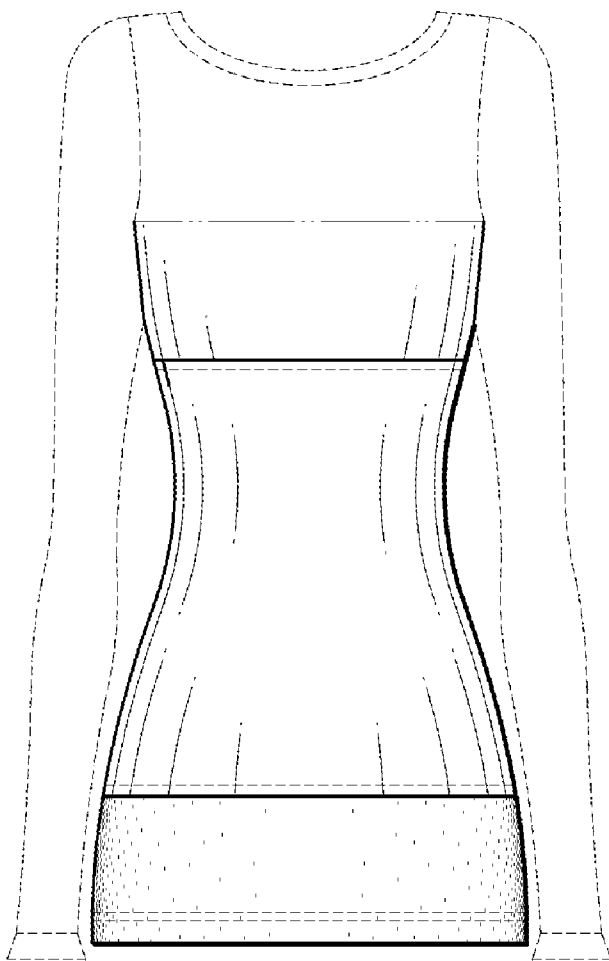

FIG. 2

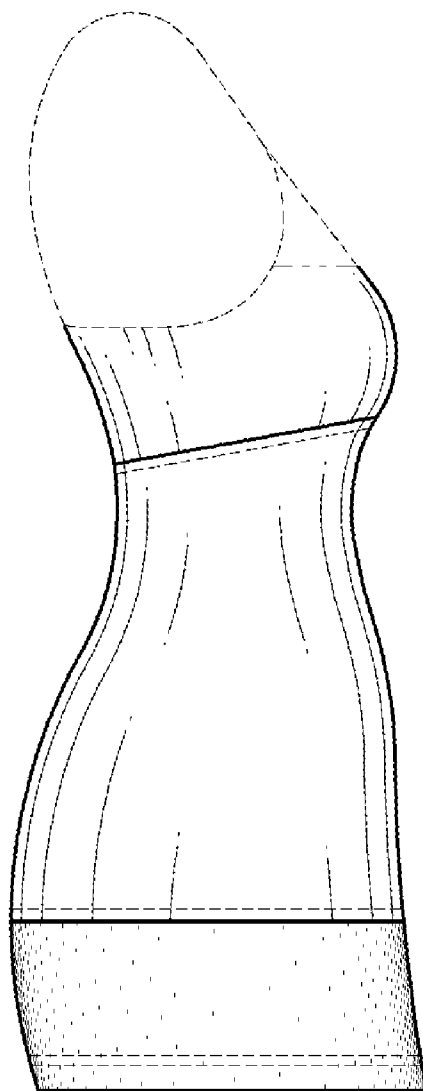

FIG. 3

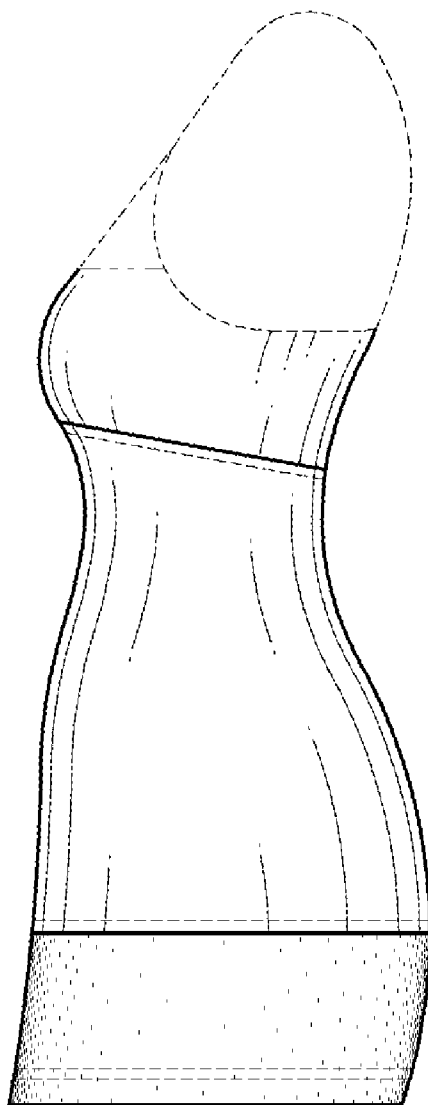

FIG. 4

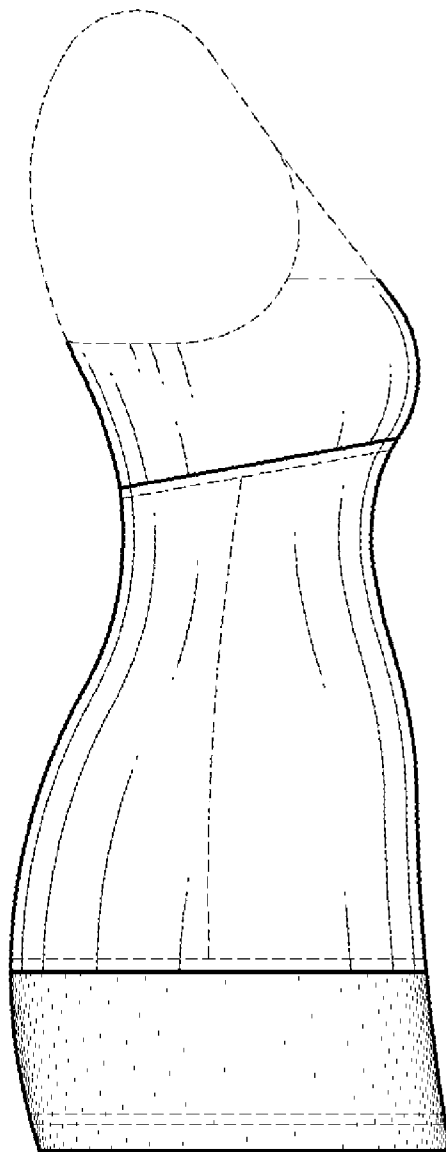

FIG. 5

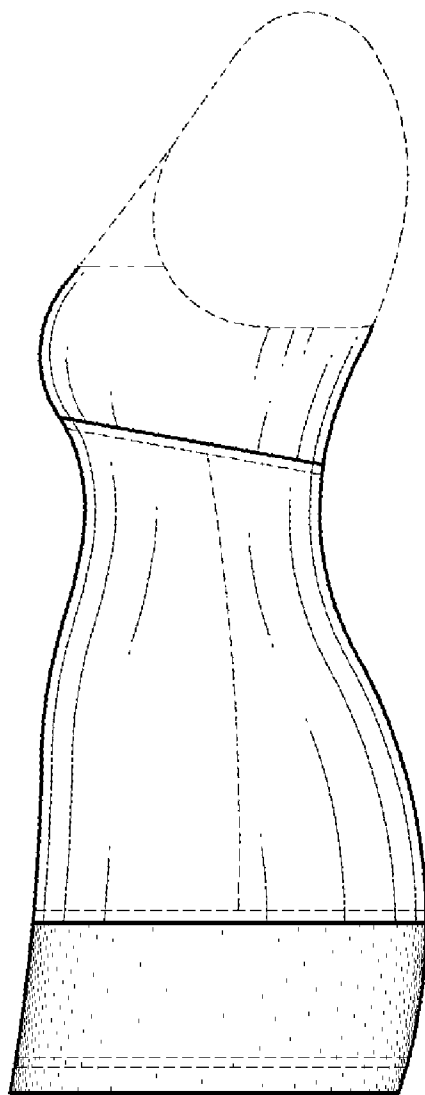

FIG. 6